



Morphettville SA

Race 6: Adelaide Galvanising Industries Adelaide Guineas - 1600m

04 May 2024 - 2:48PM



Morphettville

Track Rating: Good 4, Weather: Fine, Rail Position: +2m 1200m-W/Post; True
Remainder. Sectional 602m

| Section | | | | | | | | Overall | L1400 | L1200 | L1000 | L800 | L600 | | |
|-------------|----|--|---------|-------------------|----------------------|------------|----------------------|---------------------------|---------------------------|---------------------------|---------------------------|---------------------------|----------------------|------------------------------------|--|
| Field Times | | | | | | | | 1:38.11 (0:14.46) | 1:23.66 (0:11.53) | 1:12.12 (0:11.73) | 1:00.39 (0:11.84) | 0:48.55 (0:11.75) | 0:36.80 (0:11.79) | | |
| Position | # | Horse/Jockey | Barrier | Top Speed [km/h] | Fastest Section | First 400m | | | | | | | | Distance Travelled From Winner [m] | |
| 1 | 7 | POIFECT Michael Dee | 12 | 65.2 1600-1400 | 0:11.53 1400-1200 | 0:25.98 | 1:38.11 (0:14.45) | 1:23.66 [1] (0:11.53) | 1:12.13 [1] (0:11.74) | 1:00.39 [1] (0:11.83) | 0:48.56 [1] (0:11.76) | 0:36.80 [1] (0:11.78) | | | |
| 2 | 6 | SASSY BOOM Blake Shinn | 6 | 65.1 1600-1400 | 0:11.50 1400-1200 | 0:26.22 | 1:38.55 (0:14.72) | 1:23.83 [5] (0:11.50) | 1:12.33 [4] (0:11.91) | 1:00.42 [4] (0:11.83) | 0:48.59 [4] (0:11.89) | 0:36.70 [5] (0:11.86) | +6 | | |
| 3 | 12 | SEEKING STARDOM Jason Holder | 2 | 64.2 1600-1400 | 0:11.67 1400-1200 | 0:26.35 | 1:38.98 (0:14.68) | 1:24.30 [4] (0:11.67) | 1:12.63 [6] (0:11.92) | 1:00.71 [6] (0:11.96) | 0:48.75 [8] (0:11.82) | 0:36.93 [8] (0:11.91) | +0 | | |
| 4 | 1 | UNDER THE CONE Jake Toeroek | 11 | 65.8 1600-1400 | 0:11.51 1400-1200 | 0:26.55 | 1:39.08 (0:15.04) | 1:24.04 [11] (0:11.51) | 1:12.53 [9] (0:11.85) | 1:00.68 [9] (0:11.94) | 0:48.74 [10] (0:11.74) | 0:37.00 [10] (0:12.02) | +1 | | |
| 5 | 2 | TIPPA Lachlan Neindorf | 7 | 64.0 800-600 | 0:11.81 1400-1200 | 0:26.62 | 1:39.36 (0:14.81) | 1:24.55 [9] (0:11.81) | 1:12.74 [11] (0:11.90) | 1:00.84 [11] (0:11.84) | 0:49.00 [11] (0:11.84) | 0:37.16 [11] (0:12.02) | +8 | | |
| 6 | 10 | SPIRIT OF CAMELOT Jamie Kah | 4 | 64.7 1600-1400 | 0:11.52 1400-1200 | 0:26.08 | 1:39.49 (0:14.56) | 1:24.93 [3] (0:11.52) | 1:13.41 [3] (0:11.90) | 1:01.51 [3] (0:11.89) | 0:49.62 [3] (0:11.78) | 0:37.84 [2] (0:11.82) | -2 | | |
| 7 | 8 | STYLISH Damian Lane | 3 | 64.7 1600-1400 | 0:11.60 1400-1200 | 0:26.39 | 1:39.79 (0:14.79) | 1:25.00 [7] (0:11.60) | 1:13.40 [8] (0:11.98) | 1:01.42 [8] (0:11.87) | 0:49.55 [9] (0:11.82) | 0:37.73 [9] (0:12.15) | +6 | | |
| 8 | 5 | ARAMOSO Dom Tourneur | 5 | 63.8 800-600 | 0:11.70 1000-800 | 0:26.60 | 1:40.14 (0:14.80) | 1:25.34 [8] (0:11.80) | 1:13.54 [10] (0:11.82) | 1:01.72 [10] (0:11.70) | 0:50.02 [6] (0:11.76) | 0:38.26 [6] (0:12.04) | +8 | | |
| 9 | 3 | VOLTAGE POINT Teagan Voorham | 10 | 64.4 1600-1400 | 0:11.50 1400-1200 | 0:26.28 | 1:40.48 (0:14.78) | 1:25.70 [6] (0:11.50) | 1:14.20 [5] (0:11.87) | 1:02.33 [5] (0:11.82) | 0:50.51 [5] (0:11.70) | 0:38.81 [4] (0:11.93) | +4 | | |
| 10 | 4 | ASTRODEAN Todd Pannell | 8 | 65.8 1600-1400 | 0:11.51 1400-1200 | 0:26.07 | 1:41.98 (0:14.56) | 1:27.42 [2] (0:11.51) | 1:15.91 [2] (0:11.81) | 1:04.10 [2] (0:11.81) | 0:52.29 [2] (0:11.97) | 0:40.32 [3] (0:12.51) | +7 | | |

Scratched: Into The Light (#9)

- [] Position in running at each section and finish # Saddle cloth number
- :-:- No data available at this section DNF Did not finish
- NA No data available DNT Did not track
- █ Background shading for fastest section



RACING SA

Morphettville SA

Race 6: Adelaide Galvanising Industries Adelaide Guineas - 1600m

04 May 2024 - 2:48PM



Morphettville

Track Rating: Good 4, Weather: Fine, Rail Position: +2m 1200m-W/Post; True
Remainder. Sectional 602m

| Section | Overall | L1400 | L1200 | L1000 | L800 | L600 |
|-------------|-----------|-----------|-----------|-----------|-----------|-----------|
| Field Times | 1:38.11 | 1:23.66 | 1:12.12 | 1:00.39 | 0:48.55 | 0:36.80 |
| | (0:14.46) | (0:11.53) | (0:11.73) | (0:11.84) | (0:11.75) | (0:11.79) |

| Position | # | Horse/Jockey | Barrier | Top Speed [km/h] | Fastest Section | First 400m | Overall | L1400 | L1200 | L1000 | L800 | L600 | Distance Travelled From Winner [m] |
|----------|----|----------------|---------|------------------|-----------------|------------|-----------|--------------|-------------|-------------|-------------|-------------|------------------------------------|
| 11 | 11 | ANGELIC APPEAL | 1 | 65.3 | 0:11.54 | 0:26.38 | 1:43.21 | 1:28.37 [10] | 1:16.83 [7] | 1:04.93 [7] | 0:53.01 [7] | 0:41.28 [7] | +0 |
| | | Callan Murray | | 1600-1400 | 1400-1200 | | (0:14.84) | (0:11.54) | (0:11.90) | (0:11.92) | (0:11.73) | (0:12.05) | |

Scratched: Into The Light (#9)

- [] Position in running at each section and finish # Saddle cloth number
- :-:- No data available at this section DNF Did not finish
- NA No data available DNT Did not track
- Background shading for fastest section



RACING SA

Morphettville SA

Race 6: Adelaide Galvanising Industries Adelaide Guineas - 1600m

04 May 2024 - 2:48PM



Morphettville

Track Rating: Good 4, Weather: Fine, Rail Position: +2m 1200m-W/Post; True
Remainder. Sectional 602m

| Section | | | | L400 | L200 | | | | | | | |
|-------------|----|--------------------------|---------|------------------|-----------------|------------|--------------|--------------|---------|--|--|------------------------------------|
| Field Times | | | | 0:25.01 | 0:12.89 | | | | | | | |
| | | | | (0:12.12) | (0:12.89) | | | | | | | |
| Position | # | Horse/Jockey | Barrier | Top Speed [km/h] | Fastest Section | First 400m | | | Margin | | | Distance Travelled From Winner [m] |
| 1 | 7 | POIFECT | 12 | 65.2 | 0:11.53 | 0:25.98 | 0:25.02 [1] | 0:12.89 [1] | 1:38.11 | | | |
| | | Michael Dee | | 1600-1400 | 1400-1200 | | (0:12.13) | (0:12.89) | | | | |
| 2 | 6 | SASSY BOOM | 6 | 65.1 | 0:11.50 | 0:26.22 | 0:24.84 [4] | 0:13.00 [2] | 2.7L | | | +6 |
| | | Blake Shinn | | 1600-1400 | 1400-1200 | | (0:11.84) | (0:13.00) | | | | |
| 3 | 12 | SEEKING STARDOM | 2 | 64.2 | 0:11.67 | 0:26.35 | 0:25.02 [6] | 0:12.91 [4] | 5.3L | | | +0 |
| | | Jason Holder | | 1600-1400 | 1400-1200 | | (0:12.11) | (0:12.91) | | | | |
| 4 | 1 | UNDER THE CONE | 11 | 65.8 | 0:11.51 | 0:26.55 | 0:24.98 [8] | 0:12.86 [5] | 5.8L | | | +1 |
| | | Jake Toeroek | | 1600-1400 | 1400-1200 | | (0:12.12) | (0:12.86) | | | | |
| 5 | 2 | TIPPA | 7 | 64.0 | 0:11.81 | 0:26.62 | 0:25.14 [11] | 0:12.70 [9] | 7.5L | | | +8 |
| | | Lachlan Neindorf | | 800-600 | 1400-1200 | | (0:12.44) | (0:12.70) | | | | |
| 6 | 10 | SPIRIT OF CAMELOT | 4 | 64.7 | 0:11.52 | 0:26.08 | 0:26.02 [2] | 0:13.67 [3] | 8.3L | | | -2 |
| | | Jamie Kah | | 1600-1400 | 1400-1200 | | (0:12.35) | (0:13.67) | | | | |
| 7 | 8 | STYLISH | 3 | 64.7 | 0:11.60 | 0:26.39 | 0:25.58 [10] | 0:13.39 [7] | 10.1L | | | +6 |
| | | Damian Lane | | 1600-1400 | 1400-1200 | | (0:12.19) | (0:13.39) | | | | |
| 8 | 5 | ARAMOSO | 5 | 63.8 | 0:11.70 | 0:26.60 | 0:26.22 [5] | 0:13.64 [8] | 12.3L | | | +8 |
| | | Dom Tourneur | | 800-600 | 1000-800 | | (0:12.57) | (0:13.64) | | | | |
| 9 | 3 | VOLTAGE POINT | 10 | 64.4 | 0:11.50 | 0:26.28 | 0:26.88 [3] | 0:14.09 [6] | 14.4L | | | +4 |
| | | Teagan Voorham | | 1600-1400 | 1400-1200 | | (0:12.79) | (0:14.09) | | | | |
| 10 | 4 | ASTRODEAN | 8 | 65.8 | 0:11.51 | 0:26.07 | 0:27.81 [9] | 0:14.72 [11] | 23.4L | | | +7 |
| | | Todd Pannell | | 1600-1400 | 1400-1200 | | (0:13.09) | (0:14.72) | | | | |

Scratched: Into The Light (#9)

Report Created: Sat 04 May 2024 15:34:37 GMT+10 (Note: Timing is based on positional data)

- [] Position in running at each section and finish # Saddle cloth number
- :-:- No data available at this section DNF Did not finish
- NA No data available DNT Did not track
- █ Background shading for fastest section



Morphettville SA

Race 6: Adelaide Galvanising Industries Adelaide Guineas - 1600m

04 May 2024 - 2:48PM



Track Rating: Good 4, Weather: Fine, Rail Position: +2m 1200m-W/Post; True
Remainder. Sectional 602m

| Section | L400 | L200 |
|-------------|----------------------|----------------------|
| Field Times | 0:25.01 (0:12.12) | 0:12.89 (0:12.89) |

| Position | # | Horse/Jockey | Barrier | Top Speed [km/h] | Fastest Section | First 400m | L400 | L200 | Margin | | | | | | Distance Travelled From Winner [m] |
|----------|----|----------------|---------|------------------|-----------------|------------|-------------|--------------|--------|--|--|--|--|--|------------------------------------|
| 11 | 11 | ANGELIC APPEAL | 1 | 65.3 | 0:11.54 | 0:26.38 | 0:29.23 [7] | 0:16.21 [10] | 30.9L | | | | | | +0 |
| | | Callan Murray | | 1600-1400 | 1400-1200 | | (0:13.02) | (0:16.21) | | | | | | | |

Scratched: Into The Light (#9)

- [] Position in running at each section and finish # Saddle cloth number
- :-:- No data available at this section DNF Did not finish
- NA No data available DNT Did not track
- Background shading for fastest section

| | |
|--------------------------------|---------------------|
| Horse/Jockey Name | POIFECT/Michael Dee |
| Finish Rank | 1 |
| Fastest Section Time (Section) | 0:11.53 (L1400) |
| Top Speed [km/h] (Section) | 65.2 (Overall) |
| Race State | Finished |



Morphettville SA - Professional
 Race 6: Adelaide Galvanising Industries Adelaide Guineas - 1600m
 04 May 2024 - 2:48PM
 Track Rating: Good 4, Weather: Fine, Rail Position: +2m 1200m-W/ Post; True Remainder. Sectional 602m



| Section | Overall | L1400 | L1200 | L1000 | L800 | L600 | L400 | L200 |
|------------------------|--------------------------|--------------------------|--------------------------|--------------------------|--------------------------|--------------------------|--------------------------|--------------------------|
| Section Times | 1:38.11 [1] (0:14.45) | 1:23.66 [1] (0:11.53) | 1:12.13 [1] (0:11.74) | 1:00.39 [1] (0:11.83) | 0:48.56 [1] (0:11.76) | 0:36.80 [1] (0:11.78) | 0:25.02 [1] (0:12.13) | 0:12.89 [1] (0:12.89) |
| Average Speed [km/h] | 49.8 | 63.4 | 61.5 | 60.9 | 61.6 | 61.7 | 59.7 | 55.9 |
| Top Speed [km/h] | 65.2 | 65.2 | 63.0 | 61.1 | 62.9 | 63.2 | 61.0 | 58.2 |
| Avg. Dist. to Rail [m] | 12.0 | 4.2 | 1.1 | 1.3 | 1.3 | 2.3 | 4.3 | 5.3 |
| Avg. Stride Freq. [Hz] | 2.2 | 2.3 | 2.2 | 2.2 | 2.2 | 2.2 | 2.3 | 2.2 |
| Avg. Stride Length [m] | 6.0 | 7.7 | 7.6 | 7.7 | 7.7 | 7.6 | 7.4 | 7.1 |

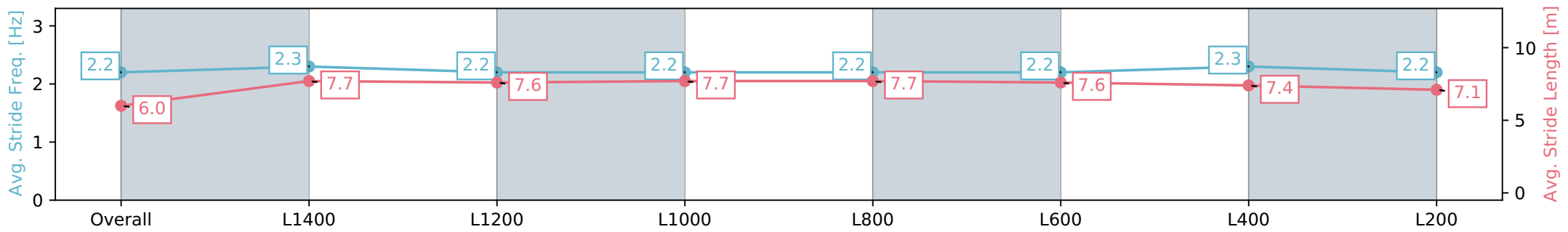
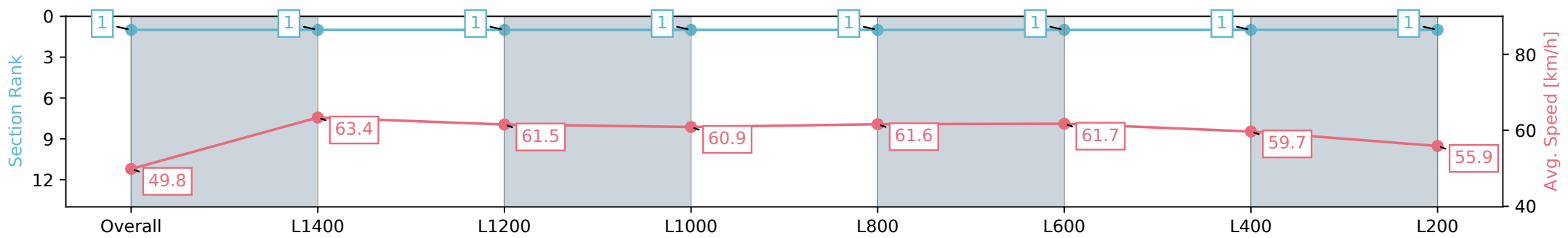

Report Created: Sat 04 May 2024 15:34:40 GMT+10 (Note: Timing is based on positional data)

- [] Ranking at each section and finish
- :-:- No data available at this section
- NA No data available

| | |
|--------------------------------|------------------------|
| Horse/Jockey Name | SASSY BOOM/Blake Shinn |
| Finish Rank | 2 |
| Fastest Section Time (Section) | 0:11.50 (L1400) |
| Top Speed [km/h] (Section) | 65.1 (Overall) |
| Race State | Finished |



Morphettville SA - Professional
 Race 6: Adelaide Galvanising Industries Adelaide Guineas - 1600m
 04 May 2024 - 2:48PM
 Track Rating: Good 4, Weather: Fine, Rail Position: +2m 1200m-W/ Post; True Remainder. Sectional 602m



| Section | Overall | L1400 | L1200 | L1000 | L800 | L600 | L400 | L200 |
|------------------------|--------------------------|--------------------------|--------------------------|--------------------------|--------------------------|--------------------------|--------------------------|--------------------------|
| Section Times | 1:38.55 [2] (0:14.72) | 1:23.83 [5] (0:11.50) | 1:12.33 [4] (0:11.91) | 1:00.42 [4] (0:11.83) | 0:48.59 [4] (0:11.89) | 0:36.70 [5] (0:11.86) | 0:24.84 [4] (0:11.84) | 0:13.00 [2] (0:13.00) |
| Average Speed [km/h] | 48.9 | 63.7 | 61.2 | 60.8 | 61.3 | 61.9 | 61.4 | 55.4 |
| Top Speed [km/h] | 65.1 | 65.0 | 64.1 | 61.9 | 62.2 | 62.5 | 62.2 | 60.0 |
| Avg. Dist. to Rail [m] | 7.1 | 4.2 | 3.3 | 2.4 | 2.8 | 3.7 | 6.9 | 6.9 |
| Avg. Stride Freq. [Hz] | 2.2 | 2.3 | 2.2 | 2.2 | 2.2 | 2.3 | 2.3 | 2.2 |
| Avg. Stride Length [m] | 5.8 | 7.7 | 7.6 | 7.7 | 7.7 | 7.6 | 7.4 | 6.9 |

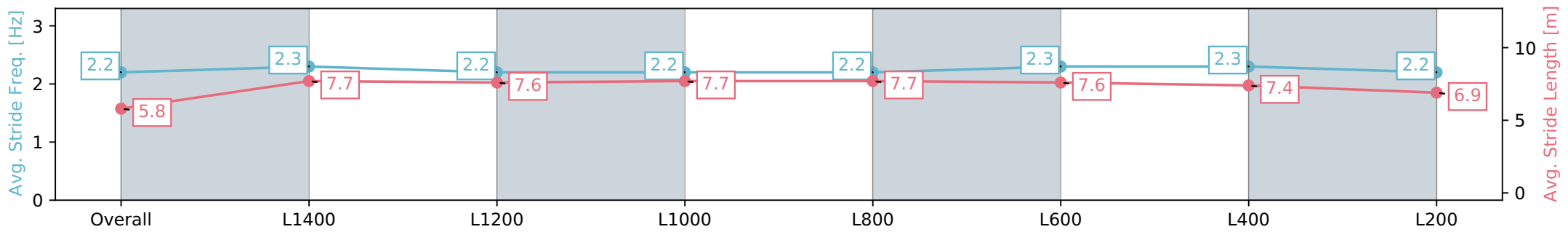
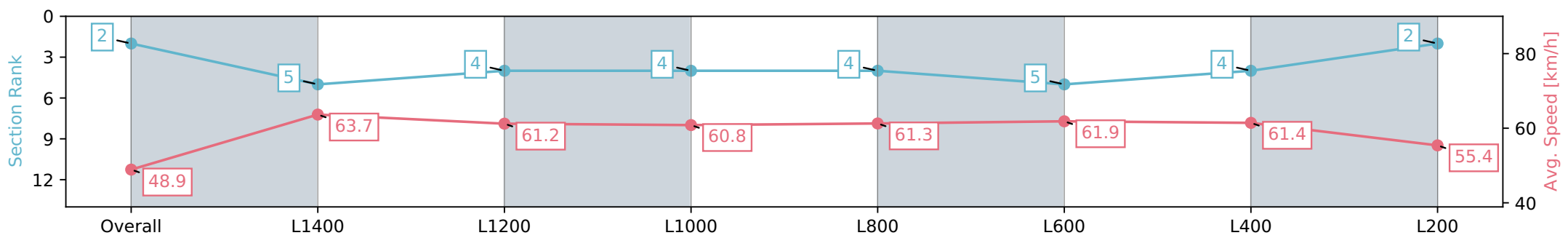

Report Created: Sat 04 May 2024 15:34:43 GMT+10 (Note: Timing is based on positional data)

- [] Ranking at each section and finish
- :-:- No data available at this section
- NA No data available

| | |
|--------------------------------|------------------------------|
| Horse/Jockey Name | SEEKING STARDOM/Jason Holder |
| Finish Rank | 3 |
| Fastest Section Time (Section) | 0:11.67 (L1400) |
| Top Speed [km/h] (Section) | 64.2 (Overall) |
| Race State | Finished |



Morphettville SA - Professional
 Race 6: Adelaide Galvanising Industries Adelaide Guineas - 1600m
 04 May 2024 - 2:48PM
 Track Rating: Good 4, Weather: Fine, Rail Position: +2m 1200m-W/ Post; True Remainder. Sectional 602m



| Section | Overall | L1400 | L1200 | L1000 | L800 | L600 | L400 | L200 |
|------------------------|--------------------------|--------------------------|--------------------------|--------------------------|--------------------------|--------------------------|--------------------------|--------------------------|
| Section Times | 1:38.98 [3] (0:14.68) | 1:24.30 [4] (0:11.67) | 1:12.63 [6] (0:11.92) | 1:00.71 [6] (0:11.96) | 0:48.75 [8] (0:11.82) | 0:36.93 [8] (0:11.91) | 0:25.02 [6] (0:12.11) | 0:12.91 [4] (0:12.91) |
| Average Speed [km/h] | 49.0 | 62.3 | 61.0 | 60.1 | 61.3 | 61.0 | 59.8 | 55.8 |
| Top Speed [km/h] | 63.1 | 64.2 | 63.7 | 61.5 | 62.7 | 62.2 | 62.2 | 58.0 |
| Avg. Dist. to Rail [m] | 3.8 | 2.5 | 2.0 | 2.1 | 2.1 | 2.0 | 2.7 | 3.4 |
| Avg. Stride Freq. [Hz] | 2.2 | 2.4 | 2.3 | 2.3 | 2.3 | 2.3 | 2.3 | 2.3 |
| Avg. Stride Length [m] | 5.8 | 7.4 | 7.4 | 7.2 | 7.3 | 7.3 | 7.0 | 6.5 |

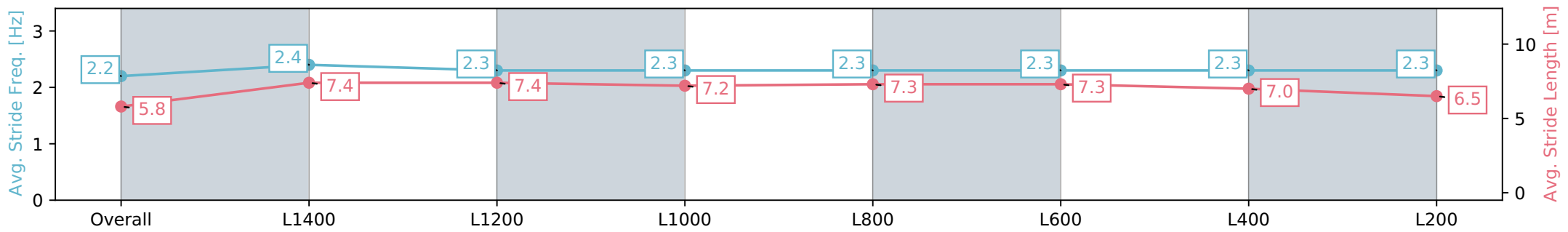
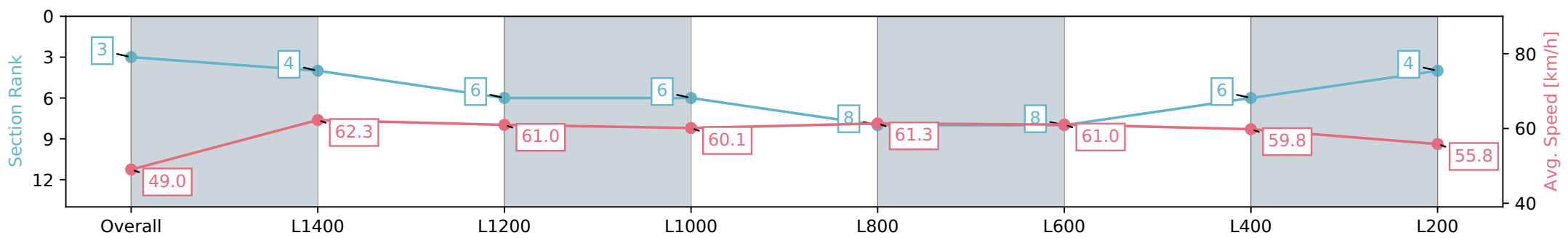

Report Created: Sat 04 May 2024 15:34:46 GMT+10 (Note: Timing is based on positional data)

- [] Ranking at each section and finish
- :-:- No data available at this section
- NA No data available

| | |
|--------------------------------|-----------------------------|
| Horse/Jockey Name | UNDER THE CONE/Jake Toeroek |
| Finish Rank | 4 |
| Fastest Section Time (Section) | 0:11.51 (L1400) |
| Top Speed [km/h] (Section) | 65.8 (Overall) |
| Race State | Finished |



Morphettville SA - Professional
 Race 6: Adelaide Galvanising Industries Adelaide Guineas - 1600m



04 May 2024 - 2:48PM

Track Rating: Good 4, Weather: Fine, Rail Position: +2m 1200m-W/ Post; True Remainder. Sectional 602m

| Section | Overall | L1400 | L1200 | L1000 | L800 | L600 | L400 | L200 |
|------------------------|--------------------------|---------------------------|--------------------------|--------------------------|---------------------------|---------------------------|--------------------------|--------------------------|
| Section Times | 1:39.08 [4] (0:15.04) | 1:24.04 [11] (0:11.51) | 1:12.53 [9] (0:11.85) | 1:00.68 [9] (0:11.94) | 0:48.74 [10] (0:11.74) | 0:37.00 [10] (0:12.02) | 0:24.98 [8] (0:12.12) | 0:12.86 [5] (0:12.86) |
| Average Speed [km/h] | 47.9 | 63.4 | 61.2 | 60.3 | 61.7 | 60.6 | 59.8 | 55.9 |
| Top Speed [km/h] | 65.4 | 65.8 | 63.2 | 62.1 | 63.4 | 63.1 | 60.9 | 59.9 |
| Avg. Dist. to Rail [m] | 9.7 | 3.2 | 2.6 | 2.4 | 1.5 | 2.3 | 3.2 | 3.1 |
| Avg. Stride Freq. [Hz] | 2.2 | 2.4 | 2.3 | 2.3 | 2.3 | 2.3 | 2.4 | 2.3 |
| Avg. Stride Length [m] | 5.7 | 7.4 | 7.2 | 7.3 | 7.4 | 7.3 | 7.0 | 6.7 |

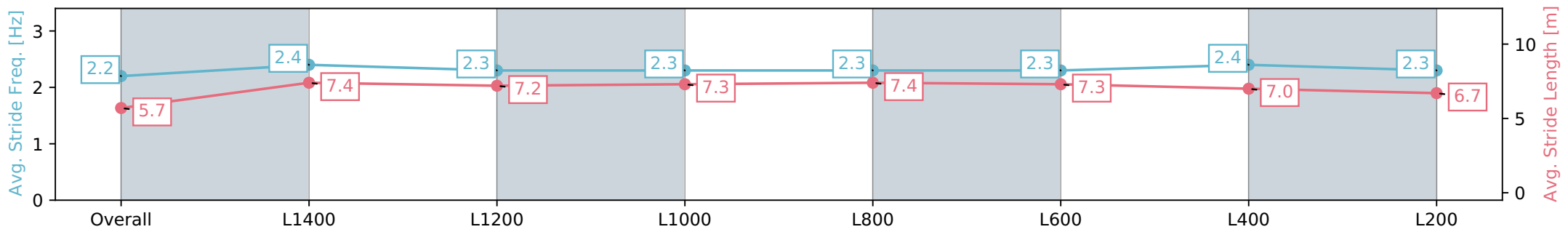
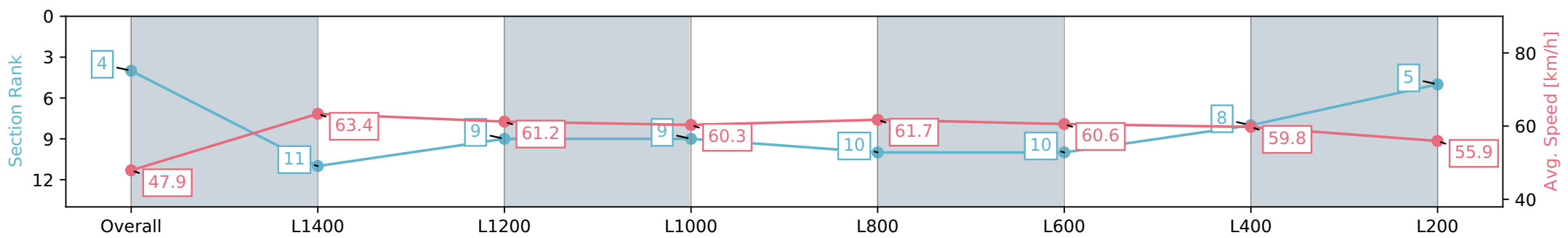

Report Created: Sat 04 May 2024 15:34:49 GMT+10 (Note: Timing is based on positional data)

- [] Ranking at each section and finish
- :-:- No data available at this section
- NA No data available

| | |
|--------------------------------|------------------------|
| Horse/Jockey Name | TIPPA/Lachlan Neindorf |
| Finish Rank | 5 |
| Fastest Section Time (Section) | 0:11.81 (L1400) |
| Top Speed [km/h] (Section) | 64.0 (L800) |
| Race State | Finished |



Morphettville SA - Professional
 Race 6: Adelaide Galvanising Industries Adelaide Guineas - 1600m
 04 May 2024 - 2:48PM
 Track Rating: Good 4, Weather: Fine, Rail Position: +2m 1200m-W/ Post; True Remainder. Sectional 602m



| Section | Overall | L1400 | L1200 | L1000 | L800 | L600 | L400 | L200 |
|------------------------|--------------------------|--------------------------|---------------------------|---------------------------|---------------------------|---------------------------|---------------------------|--------------------------|
| Section Times | 1:39.36 [5] (0:14.81) | 1:24.55 [9] (0:11.81) | 1:12.74 [11] (0:11.90) | 1:00.84 [11] (0:11.84) | 0:49.00 [11] (0:11.84) | 0:37.16 [11] (0:12.02) | 0:25.14 [11] (0:12.44) | 0:12.70 [9] (0:12.70) |
| Average Speed [km/h] | 48.6 | 62.3 | 61.4 | 60.9 | 61.6 | 61.1 | 58.4 | 56.7 |
| Top Speed [km/h] | 63.2 | 63.9 | 63.3 | 63.1 | 63.7 | 64.0 | 59.9 | 59.9 |
| Avg. Dist. to Rail [m] | 8.7 | 5.9 | 4.0 | 3.2 | 3.1 | 4.0 | 6.9 | 8.4 |
| Avg. Stride Freq. [Hz] | 2.3 | 2.4 | 2.4 | 2.3 | 2.3 | 2.3 | 2.3 | 2.3 |
| Avg. Stride Length [m] | 5.5 | 7.2 | 7.3 | 7.2 | 7.3 | 7.3 | 6.9 | 6.8 |

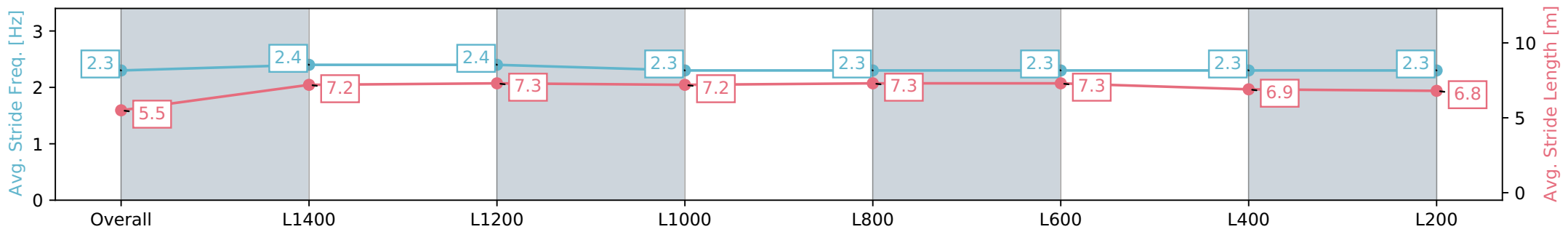
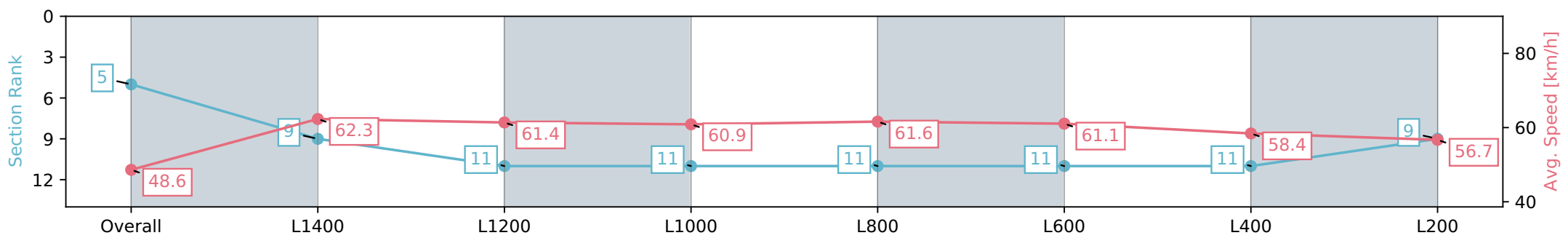

Report Created: Sat 04 May 2024 15:34:52 GMT+10 (Note: Timing is based on positional data)

- [] Ranking at each section and finish
- :-:- No data available at this section
- NA No data available

| | |
|--------------------------------|-----------------------------|
| Horse/Jockey Name | SPIRIT OF CAMELOT/Jamie Kah |
| Finish Rank | 6 |
| Fastest Section Time (Section) | 0:11.52 (L1400) |
| Top Speed [km/h] (Section) | 64.7 (Overall) |
| Race State | Finished |



Morphettville SA - Professional
 Race 6: Adelaide Galvanising Industries Adelaide Guineas - 1600m



04 May 2024 - 2:48PM

Track Rating: Good 4, Weather: Fine, Rail Position: +2m 1200m-W/ Post; True Remainder. Sectional 602m

| Section | Overall | L1400 | L1200 | L1000 | L800 | L600 | L400 | L200 |
|------------------------|--------------------------|--------------------------|--------------------------|--------------------------|--------------------------|--------------------------|--------------------------|--------------------------|
| Section Times | 1:39.49 [6] (0:14.56) | 1:24.93 [3] (0:11.52) | 1:13.41 [3] (0:11.90) | 1:01.51 [3] (0:11.89) | 0:49.62 [3] (0:11.78) | 0:37.84 [2] (0:11.82) | 0:26.02 [2] (0:12.35) | 0:13.67 [3] (0:13.67) |
| Average Speed [km/h] | 49.4 | 63.1 | 60.6 | 60.6 | 61.4 | 61.3 | 58.6 | 52.7 |
| Top Speed [km/h] | 64.5 | 64.7 | 62.4 | 61.6 | 62.7 | 62.5 | 60.5 | 55.9 |
| Avg. Dist. to Rail [m] | 6.3 | 2.5 | 0.8 | 1.1 | 1.2 | 1.6 | 3.3 | 4.6 |
| Avg. Stride Freq. [Hz] | 2.3 | 2.4 | 2.3 | 2.3 | 2.3 | 2.4 | 2.3 | 2.2 |
| Avg. Stride Length [m] | 5.6 | 7.3 | 7.3 | 7.3 | 7.1 | 7.0 | 6.8 | 6.5 |

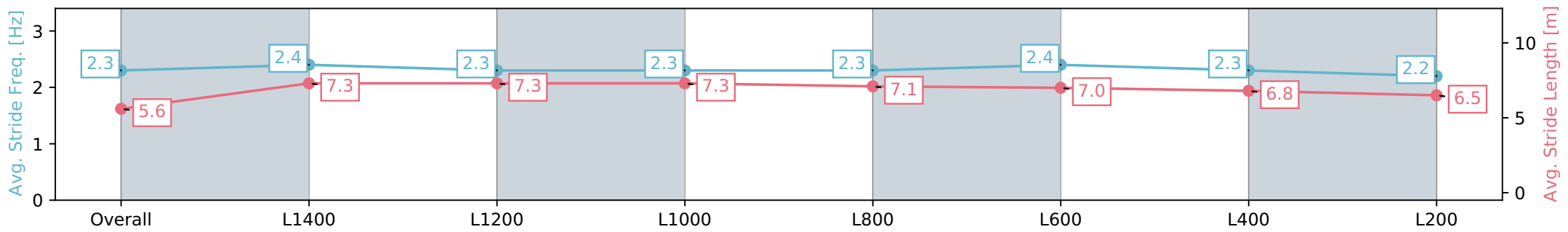
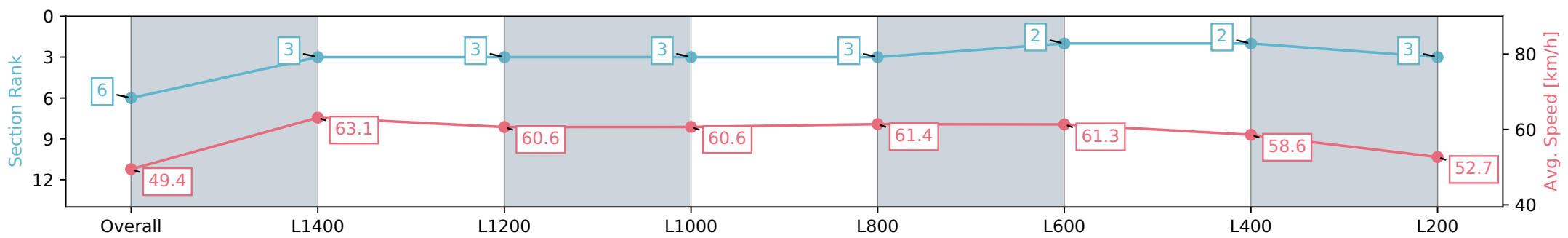

Report Created: Sat 04 May 2024 15:34:55 GMT+10 (Note: Timing is based on positional data)

- [] Ranking at each section and finish
- :-:- No data available at this section
- NA No data available

| | |
|--------------------------------|---------------------|
| Horse/Jockey Name | STYLISH/Damian Lane |
| Finish Rank | 7 |
| Fastest Section Time (Section) | 0:11.60 (L1400) |
| Top Speed [km/h] (Section) | 64.7 (Overall) |
| Race State | Finished |



Morphettville SA - Professional
 Race 6: Adelaide Galvanising Industries Adelaide Guineas - 1600m



04 May 2024 - 2:48PM

Track Rating: Good 4, Weather: Fine, Rail Position: +2m 1200m-W/ Post; True Remainder. Sectional 602m

| Section | Overall | L1400 | L1200 | L1000 | L800 | L600 | L400 | L200 |
|------------------------|--------------------------|--------------------------|--------------------------|--------------------------|--------------------------|--------------------------|---------------------------|--------------------------|
| Section Times | 1:39.79 [7] (0:14.79) | 1:25.00 [7] (0:11.60) | 1:13.40 [8] (0:11.98) | 1:01.42 [8] (0:11.87) | 0:49.55 [9] (0:11.82) | 0:37.73 [9] (0:12.15) | 0:25.58 [10] (0:12.19) | 0:13.39 [7] (0:13.39) |
| Average Speed [km/h] | 48.8 | 62.9 | 60.8 | 60.7 | 61.7 | 60.6 | 59.6 | 53.7 |
| Top Speed [km/h] | 63.9 | 64.7 | 62.9 | 62.1 | 63.3 | 63.2 | 61.5 | 58.2 |
| Avg. Dist. to Rail [m] | 4.8 | 3.7 | 2.8 | 3.7 | 3.9 | 4.2 | 7.8 | 10.2 |
| Avg. Stride Freq. [Hz] | 2.2 | 2.4 | 2.3 | 2.3 | 2.3 | 2.3 | 2.3 | 2.2 |
| Avg. Stride Length [m] | 5.9 | 7.3 | 7.3 | 7.5 | 7.5 | 7.4 | 7.2 | 6.7 |

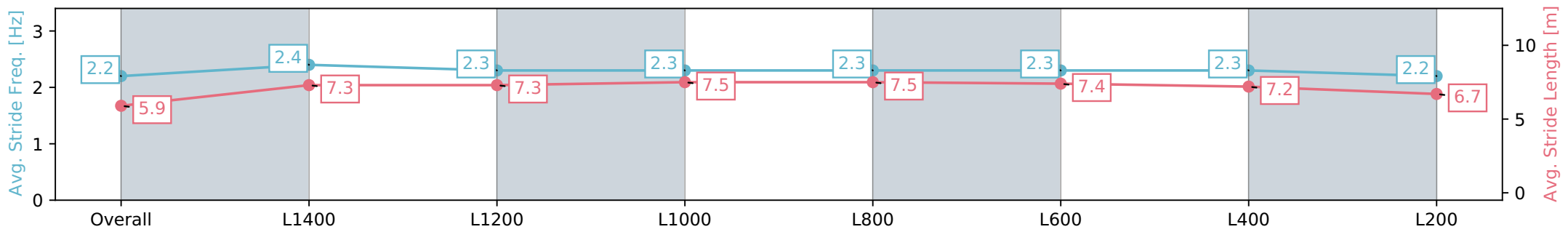
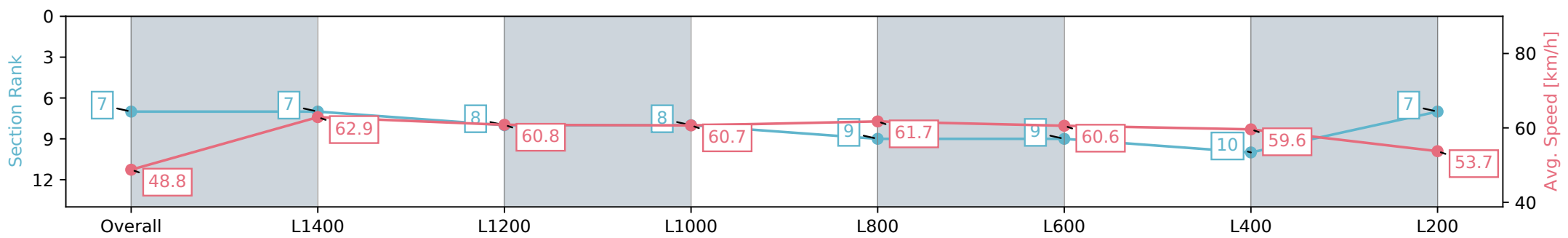

Report Created: Sat 04 May 2024 15:34:58 GMT+10 (Note: Timing is based on positional data)

- [] Ranking at each section and finish
- :-:- No data available at this section
- NA No data available

| | |
|--------------------------------|----------------------|
| Horse/Jockey Name | ARAMOSO/Dom Tourneur |
| Finish Rank | 8 |
| Fastest Section Time (Section) | 0:11.70 (L1000) |
| Top Speed [km/h] (Section) | 63.8 (L800) |
| Race State | Finished |



Morphettville SA - Professional
 Race 6: Adelaide Galvanising Industries Adelaide Guineas - 1600m
 04 May 2024 - 2:48PM
 Track Rating: Good 4, Weather: Fine, Rail Position: +2m 1200m-W/ Post; True Remainder. Sectional 602m



| Section | Overall | L1400 | L1200 | L1000 | L800 | L600 | L400 | L200 |
|------------------------|--------------------------|--------------------------|---------------------------|---------------------------|--------------------------|--------------------------|--------------------------|--------------------------|
| Section Times | 1:40.14 [8] (0:14.80) | 1:25.34 [8] (0:11.80) | 1:13.54 [10] (0:11.82) | 1:01.72 [10] (0:11.70) | 0:50.02 [6] (0:11.76) | 0:38.26 [6] (0:12.04) | 0:26.22 [5] (0:12.57) | 0:13.64 [8] (0:13.64) |
| Average Speed [km/h] | 48.7 | 61.9 | 61.6 | 61.5 | 62.0 | 61.4 | 58.0 | 52.8 |
| Top Speed [km/h] | 63.3 | 63.4 | 62.5 | 63.1 | 63.7 | 63.8 | 59.7 | 55.9 |
| Avg. Dist. to Rail [m] | 6.4 | 3.9 | 3.0 | 4.3 | 3.6 | 5.4 | 8.5 | 10.1 |
| Avg. Stride Freq. [Hz] | 2.2 | 2.3 | 2.3 | 2.2 | 2.3 | 2.3 | 2.3 | 2.2 |
| Avg. Stride Length [m] | 5.8 | 7.5 | 7.6 | 7.6 | 7.5 | 7.4 | 7.2 | 6.8 |

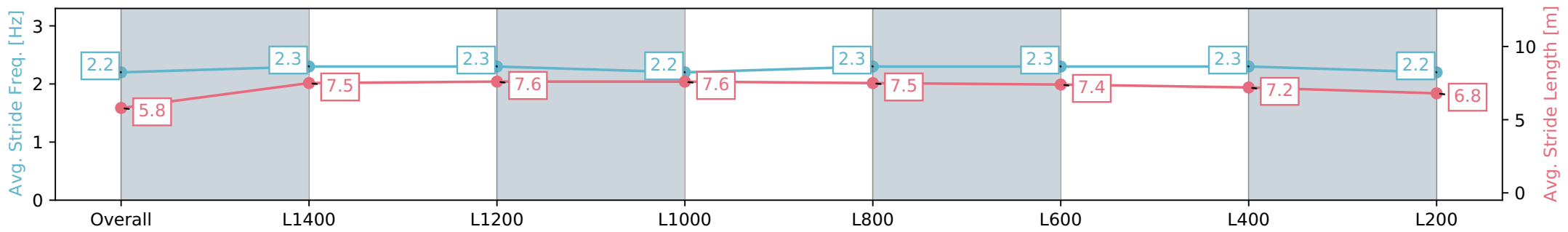
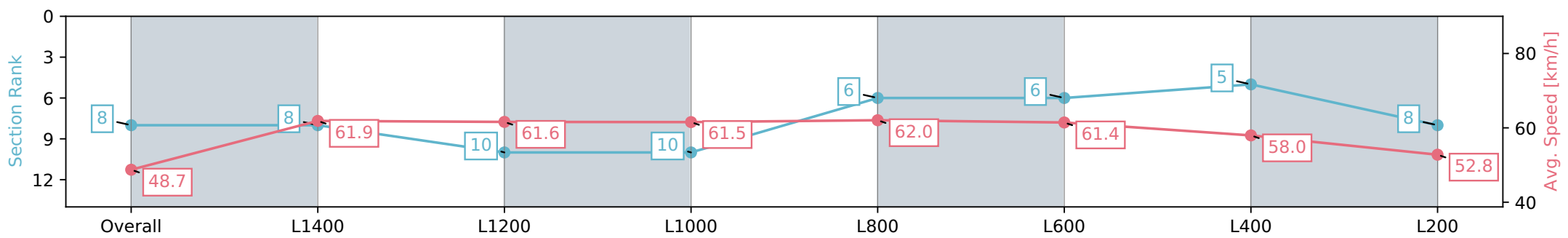

Report Created: Sat 04 May 2024 15:35:01 GMT+10 (Note: Timing is based on positional data)

- [] Ranking at each section and finish
- :-:- No data available at this section
- NA No data available



| | |
|--------------------------------|------------------------------|
| Horse/Jockey Name | VOLTAGE POINT/Teagan Voorham |
| Finish Rank | 9 |
| Fastest Section Time (Section) | 0:11.50 (L1400) |
| Top Speed [km/h] (Section) | 64.4 (Overall) |
| Race State | Finished |



Morphettville SA - Professional
 Race 6: Adelaide Galvanising Industries Adelaide Guineas - 1600m
 04 May 2024 - 2:48PM
 Track Rating: Good 4, Weather: Fine, Rail Position: +2m 1200m-W/ Post; True Remainder. Sectional 602m



| Section | Overall | L1400 | L1200 | L1000 | L800 | L600 | L400 | L200 |
|------------------------|--------------------------|--------------------------|--------------------------|--------------------------|--------------------------|--------------------------|--------------------------|--------------------------|
| Section Times | 1:40.48 [9] (0:14.78) | 1:25.70 [6] (0:11.50) | 1:14.20 [5] (0:11.87) | 1:02.33 [5] (0:11.82) | 0:50.51 [5] (0:11.70) | 0:38.81 [4] (0:11.93) | 0:26.88 [3] (0:12.79) | 0:14.09 [6] (0:14.09) |
| Average Speed [km/h] | 48.7 | 63.8 | 61.3 | 60.8 | 62.1 | 61.4 | 56.7 | 51.1 |
| Top Speed [km/h] | 64.1 | 64.4 | 62.6 | 61.9 | 63.1 | 62.7 | 59.3 | 53.6 |
| Avg. Dist. to Rail [m] | 8.6 | 4.7 | 2.6 | 2.8 | 2.6 | 3.5 | 4.2 | 7.3 |
| Avg. Stride Freq. [Hz] | 2.3 | 2.3 | 2.3 | 2.2 | 2.3 | 2.3 | 2.3 | 2.2 |
| Avg. Stride Length [m] | 5.7 | 7.6 | 7.5 | 7.5 | 7.5 | 7.3 | 7.0 | 6.6 |

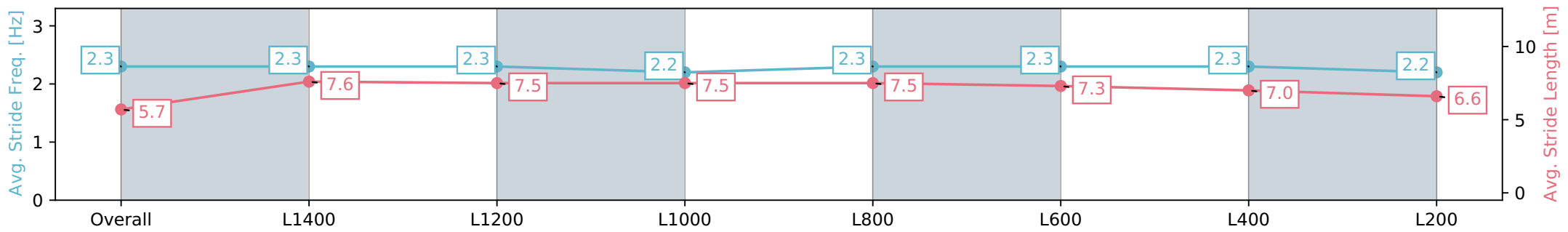
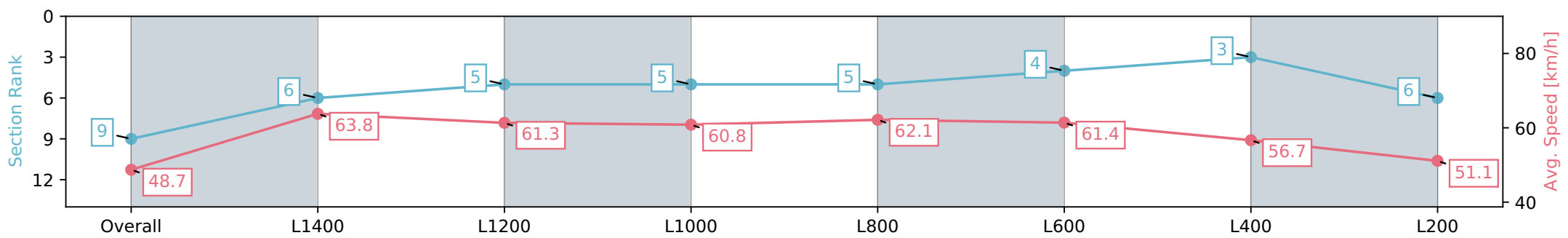

Report Created: Sat 04 May 2024 15:35:05 GMT+10 (Note: Timing is based on positional data)

- [] Ranking at each section and finish
- :-:- No data available at this section
- NA No data available

| | |
|--------------------------------|------------------------|
| Horse/Jockey Name | ASTRODEAN/Todd Pannell |
| Finish Rank | 10 |
| Fastest Section Time (Section) | 0:11.51 (L1400) |
| Top Speed [km/h] (Section) | 65.8 (Overall) |
| Race State | Finished |



Morphettville SA - Professional
 Race 6: Adelaide Galvanising Industries Adelaide Guineas - 1600m
 04 May 2024 - 2:48PM
 Track Rating: Good 4, Weather: Fine, Rail Position: +2m 1200m-W/ Post; True Remainder. Sectional 602m



| Section | Overall | L1400 | L1200 | L1000 | L800 | L600 | L400 | L200 |
|------------------------|---------------------------|--------------------------|--------------------------|--------------------------|--------------------------|--------------------------|--------------------------|---------------------------|
| Section Times | 1:41.98 [10] (0:14.56) | 1:27.42 [2] (0:11.51) | 1:15.91 [2] (0:11.81) | 1:04.10 [2] (0:11.81) | 0:52.29 [2] (0:11.97) | 0:40.32 [3] (0:12.51) | 0:27.81 [9] (0:13.09) | 0:14.72 [11] (0:14.72) |
| Average Speed [km/h] | 49.5 | 63.9 | 61.9 | 60.9 | 60.7 | 58.7 | 55.5 | 48.9 |
| Top Speed [km/h] | 64.0 | 65.8 | 64.1 | 62.7 | 61.5 | 60.7 | 57.2 | 53.8 |
| Avg. Dist. to Rail [m] | 10.2 | 5.8 | 3.7 | 3.0 | 2.5 | 4.1 | 4.9 | 5.4 |
| Avg. Stride Freq. [Hz] | 2.2 | 2.3 | 2.2 | 2.2 | 2.2 | 2.2 | 2.2 | 2.0 |
| Avg. Stride Length [m] | 6.0 | 7.8 | 7.8 | 7.5 | 7.4 | 7.3 | 7.1 | 6.6 |

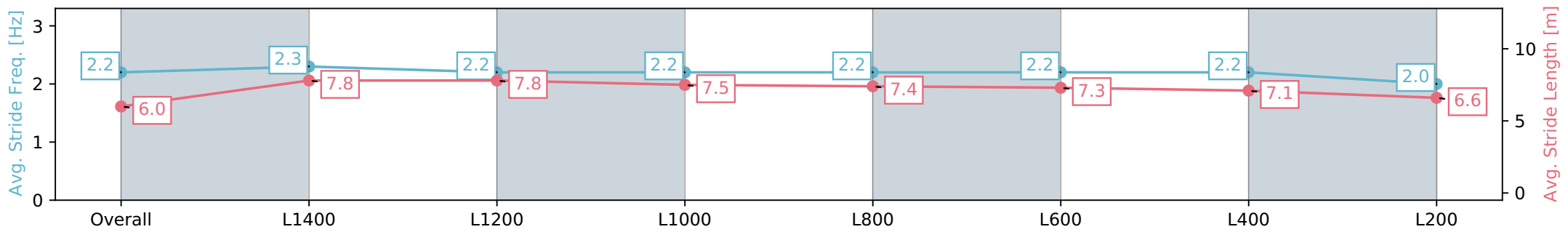
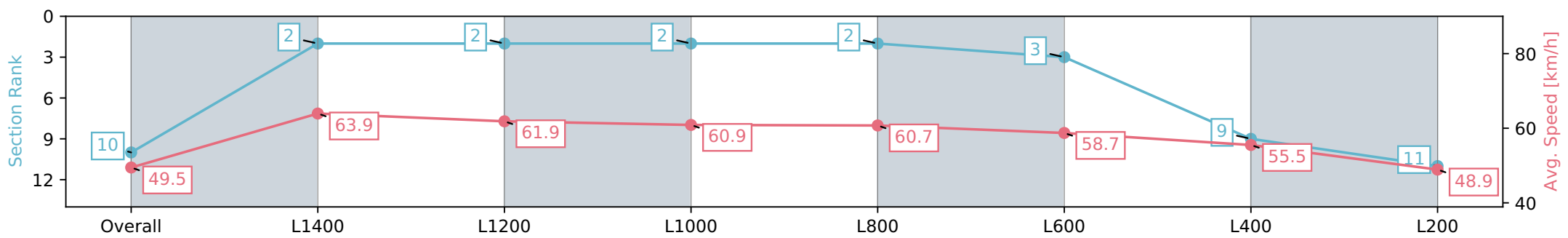

Report Created: Sat 04 May 2024 15:35:08 GMT+10 (Note: Timing is based on positional data)

- [] Ranking at each section and finish
- :-:- No data available at this section
- NA No data available

| | |
|--------------------------------|------------------------------|
| Horse/Jockey Name | ANGELIC APPEAL/Callan Murray |
| Finish Rank | 11 |
| Fastest Section Time (Section) | 0:11.54 (L1400) |
| Top Speed [km/h] (Section) | 65.3 (Overall) |
| Race State | Finished |



Morphettville SA - Professional
 Race 6: Adelaide Galvanising Industries Adelaide Guineas - 1600m
 04 May 2024 - 2:48PM
 Track Rating: Good 4, Weather: Fine, Rail Position: +2m 1200m-W/ Post; True Remainder. Sectional 602m



| Section | Overall | L1400 | L1200 | L1000 | L800 | L600 | L400 | L200 |
|------------------------|---------------------------|---------------------------|--------------------------|--------------------------|--------------------------|--------------------------|--------------------------|---------------------------|
| Section Times | 1:43.21 [11] (0:14.84) | 1:28.37 [10] (0:11.54) | 1:16.83 [7] (0:11.90) | 1:04.93 [7] (0:11.92) | 0:53.01 [7] (0:11.73) | 0:41.28 [7] (0:12.05) | 0:29.23 [7] (0:13.02) | 0:16.21 [10] (0:16.21) |
| Average Speed [km/h] | 48.6 | 63.1 | 61.0 | 60.4 | 61.8 | 60.5 | 55.3 | 44.5 |
| Top Speed [km/h] | 64.0 | 65.3 | 62.2 | 61.9 | 63.6 | 62.6 | 59.0 | 50.6 |
| Avg. Dist. to Rail [m] | 2.2 | 2.6 | 2.1 | 2.1 | 2.2 | 2.1 | 0.9 | 0.9 |
| Avg. Stride Freq. [Hz] | 2.3 | 2.4 | 2.3 | 2.3 | 2.3 | 2.4 | 2.3 | 2.1 |
| Avg. Stride Length [m] | 5.5 | 7.2 | 7.2 | 7.2 | 7.3 | 7.0 | 6.7 | 6.0 |

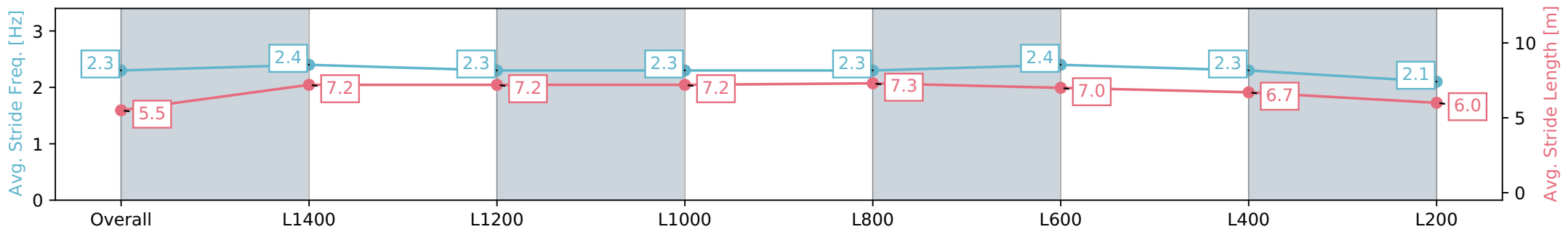
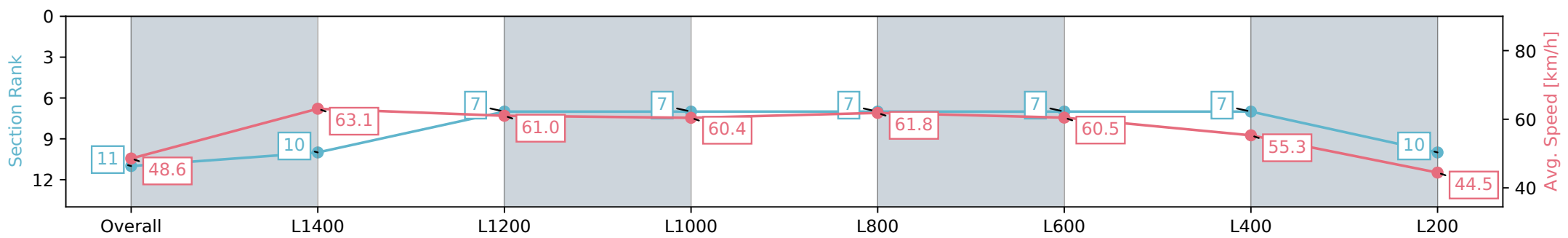

Report Created: Sat 04 May 2024 15:35:12 GMT+10 (Note: Timing is based on positional data)

- [] Ranking at each section and finish
- :-:- No data available at this section
- NA No data available